

PTZ-35 MS

PTZ-50 MS

Installation and Operation Manual



May 2008

FLIR Systems, Inc.
70 Castilian Drive
Goleta, CA 93117
Phone: 888.747.FLIR (888.747.3547)
International: +1.805.964.9797

[http:// www.flir.com](http://www.flir.com)

FLIR Systems Inc.**70 Castilian Dr.****Goleta, CA 93117-3027****888.747.FLIR (888.747.3547)****Intl.: +1.805.964.9797****FAX 805 685-2711****www.flir.com****Document Number: 427-0016-00-10****Revision Number: 120****Date: March, 2008****EXPORT RESTRICTIONS**

The information contained in this document may be controlled for export purposes by the United States Government. Diversion contrary to US law is prohibited. For more information, contact FLIR Systems, Inc. This document and data disclosed herein or herewith is not to be reproduced, used, or disclosed in whole or in part to anyone without the permission of FLIR Systems, Inc.

PROPRIETARY

The data in this publication shall not be disclosed without permission and shall not be duplicated, used, or disclosed in whole or in part except to the extent provided in any contract of which this document is made a part. This restriction does not limit the customer's right to use information contained in this document if it is obtainable from another source without restriction. The data subject to this restriction are contained in all sheets of this document and related drawings and document specifications herein. FLIR reserves the right to make changes to its products or specifications at any time, without notice, in order to improve design or performance and to supply the best possible product.

COPYRIGHT

Copyright © 2008 by FLIR Systems, Inc. All rights reserved. This publication, or any parts thereof, may not be reproduced in any form without the express written permission of FLIR Systems, Inc.

Pelco is a registered trademark of Pelco. Windows is a registered trademark of Microsoft Corporation.

TABLE OF CONTENTS

1.0 WARNINGS AND CAUTIONS	5
2.0 INTRODUCTION	6
2.1 Advantages of Thermal Imaging.....	7
2.2 Package Contents	8
3.0 QUICK-START INFORMATION.....	9
4.0 PTZ-35 MS / PTZ-50 MS USER INTERFACE.....	10
Communication Panel	11
Pan/Tilt Panel	13
Infrared Panel.....	14
DLTV Panel	16
Manual Control Panel.....	17
5.0 PTZ-35 MS / PTZ-50 MS PHYSICAL INTERFACE	19
Dimension Drawings	19
Integrated Interface Cable Connector	21
Break-Out Connector Cable	22
6.0 MAINTENANCE	23
6.1 Lens Cleaning.....	23
7.0 PTZ-35 MS / PTZ-50 MS SPECIFICATIONS	24
8.0 OPTIONAL JOYSTICK DISPLAY UNIT	26
8.1 Joystick Control w/ Display Unit	26
Joystick operation.....	26
Joystick drift.....	27
9.0 SOFTWARE CONTROL FUNCTIONS.....	28
9.1 Software Interface Description	28
9.2 IR Imager	28
9.3 Daylight Camera.....	31
9.4 Pan/Tilt Mechanism	32
10.0 USER CONTROLS FOR KBD300A	35

TABLE OF FIGURES

Figure 1: PTZ-35 MS and PTZ-50 MS provide 24/7 threat detection	4
Figure 2: Daylight camera on left; Thermal image on right	6
Figure 3: Backlit daylight camera on left; thermal image on right	7
Figure 4: PTZ-35 MS / PTZ-50 MS camera foot and mounting bracket shoe	8
Figure 5: Quick Connect Interface Cable w/ break-out pigtail shown at bottom insert.....	9
Figure 6: PTZ-35 MS / PTZ-50 MS User Interface	10
Figure 8: PTZ-35 MS / PTZ-50 MS Communication panel	11
Figure 9: PTZ-35 MS / PTZ-50 MS Pan/Tilt panel	13
Figure 10: PTZ-35 MS / PTZ-50 MS Infrared panel.....	15
Figure 11: PTZ-35 MS / PTZ-50 MS Infrared panel.....	16
Figure 12: PTZ-35 MS / PTZ-50 MS DLTV panel	17
Figure 13: PTZ-35 MS / PTZ-50 MS Manual Control.....	18
Figure 14: PTZ-35 MS / PTZ-50 MS Dimension Drawing.....	19
Figure 15: PTZ-35 MS / PTZ-50 MS Dimension Drawing with hole pattern.....	20
Figure 16: PTZ-35 MS / PTZ-50 MS Interface Cable Connector	21
Figure 18: IR Video Output Figure 19: DLTV video output.....	22
Figure 20: RS-232 DB-9 (Female) Figure 21: RS-422 DB-9 (Male)	22
Figure 22: Joystick Display Unit.....	26
Figure 23: Operational Directions on back of Joystick Display Unit.....	27



Figure 1: PTZ-35 MS and PTZ-50 MS provide 24/7 threat detection

1.0 WARNINGS AND CAUTIONS

Caution! This guide uses the term **Caution!** to indicate a potentially hazardous situation, which, if not avoided, may result in bodily harm or injury, damage to the camera, or other property damage.

Protect Your Investment

The enclosure of the PTZ-35 MS and PTZ-50 MS visible camera is pressurized with nitrogen to eliminate fogging of the camera lens due to sudden changes in temperature.

The camera should be installed by a trained professional according to local codes and industry-standard safe practices.

Proper ESD protocol should be followed while working with the unit.

Do not disassemble the PTZ-35 MS and PTZ-50 MS enclosures. Disassembly can cause permanent damage and will void the warranty.

Operating the PTZ-35 MS or PTZ-50 MS outside of its specified operating temperature range or voltage range can cause permanent damage and will void the warranty.

The camera is a precision optical instrument and should not be exposed to excessive shock or vibration.

When not in use, replace the lens cap over the objective lens. When the lens cap is not in place, avoid pointing the system directly at extremely high-intensity radiation sources, such as the sun, lasers, arc welders, etc. This warning applies whether or not the system is powered.

Great care should be used with your camera's optics. They are delicate and can be damaged by improper cleaning. Only clean the lens in the manner described in section 6.0 [Maintenance](#).

Legal Considerations

Camera and audio surveillance may be prohibited by laws that vary from country to country. Check the laws in your local region before using this product for surveillance purposes.

Support

If you have questions that are not covered in this manual, or need service, contact FLIR Customer Support at (805) 964-9797 for additional information prior to returning your PTZ-35/-50 MS thermal camera. In the US, you can also reach FLIR Customer Support at (888) 747-FLIR (747-3547).

All thermal imaging systems are subject to export control. Please contact FLIR for export compliance information concerning your application or geographic area.

2.0 INTRODUCTION

The PTZ-35 MS and PTZ-50 MS are high-resolution multi-sensor camera systems designed specifically for the security market. These small, pan/tilt systems feature a powerful thermal camera, with 35mm or 50mm lens, as well as a standard high resolution low-light video camera¹, integrated into a compact weather tight pan and tilt enclosure. The systems can be configured for portable or point-to-point use, and are compatible with Pelco D protocol (using RS-232 or RS422, depending on the configuration ordered) and Nexus communications. They are perfect for security and surveillance applications that demand compact size and rugged performance.

The FLIR system you have purchased includes a sophisticated thermal imaging camera that provides excellent night visibility and situational awareness, even in absolute darkness. The camera has a standard video output that works with digital video recording devices, video motion detection software or off-the-shelf video encoders. Thermal imagers are well suited to video analytics – a combination of best-in-class intruder detection cameras with intelligent 24-hour automated monitoring. Day or night, thermal cameras provide excellent scene contrast, critical for high-reliability and reduced false alarms, even during daylight hours.

FLIR's powerful thermal security cameras compliment and complete your security camera network. They turn night into day, allowing you to see intruders invisible to the naked eye. FLIR PTZ cameras create video images from infrared thermal energy (heat), and perform well at night and day, in good weather and bad. The thermal camera system is intended for various commercial and industrial uses, including security and surveillance applications, such as border / perimeter patrol and security inspection.

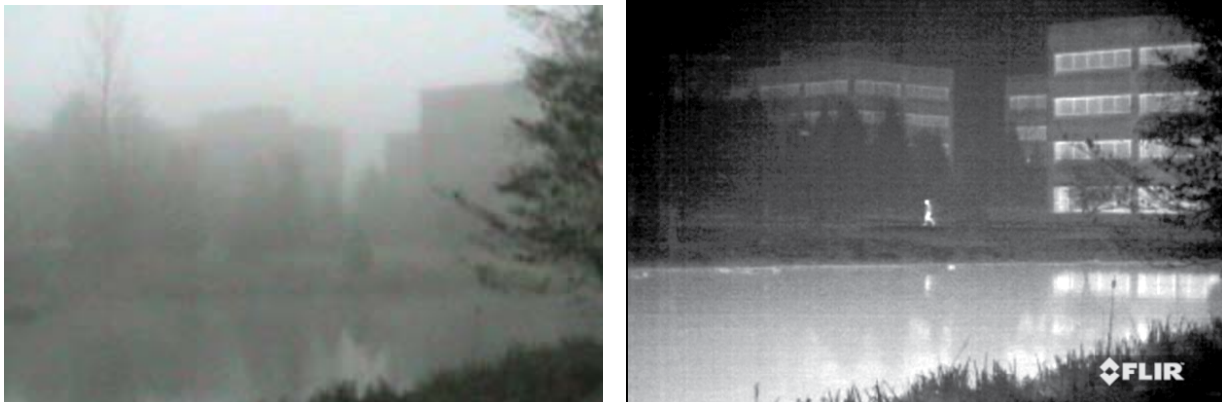

Figure 2: Daylight camera on left; Thermal camera on right

Observe that the image on the left from an ordinary daylight camera is obscured by fog; the thermal image on the right provides clear details.

The PTZ-35/-50 MS camera is designed for simple, intuitive installation and operation. Each thermal camera is based on FLIR's widely-deployed uncooled microbolometer imaging core. All cameras include FLIR's advanced image processing techniques which deliver excellent contrast regardless of scene dynamics.

This camera has a sealed outdoor enclosure that is designed to protect the camera and lens components in adverse environmental conditions. The sealed enclosure increases the camera reliability and reduces the cost of maintenance.

¹ The standard video camera is referred to in this manual generally as a daylight camera or DLTV.

PTZ-35 MS

The PTZ-35 MS camera features a focal length of 35mm, providing a short to medium field of view of 20° and is well-suited for short range threat detection in all circumstances. It gives you a wide field of view, so you can cover a large area and keep excellent situational awareness. Like all FLIR thermal cameras, the PTZ-35 MS provides crisp, clear thermal imagery in total darkness, haze, light fog or smoke.

PTZ-50 MS

Utilizing a 50mm lens, the PTZ-50 MS serves as a medium- to long-range surveillance camera and provides a 14° HFOV. This focal length is widely deployed because it provides an even balance between situational awareness and detailed perspective. Like the PTZ-35 MS camera, the PTZ-50 MS has a standard resolution focal plane array (FPA) with 320 (H) x 240 (V) pixels, the same thermal imaging technology found in many of FLIR's most sophisticated security and surveillance systems.

2.1 Advantages of Thermal Imaging

Originally developed for the military, thermal imaging cameras are now deployed in numerous commercial applications where it is impractical or too expensive to use active illumination (lights). It is perfect for wide-area surveillance in critical infrastructure or high-value residence installations where lighting is unwelcome or impractical. The camera also provides improved daytime surveillance in environments where traditional CCTV security camera performance suffers, such as in shadows, backlit scenes or through foliage.

Low-cost infrared illuminated cameras rely on near infrared (NIR) lamps to illuminate threats, resulting in shadows, reflections, backscatter, higher power consumption, narrow areas of illumination and much shorter ranges than passive thermal camera technology.

Unlike other night vision systems that require low amounts of light to generate an image, the PTZ-35/-50 MS thermal imagers need no light at all. The choice of lenses for the cameras allow for short- or medium-range surveillance capability.



Figure 3: Backlit daylight camera on left; thermal camera on right

Observe that the setting sun in the backlit image on the left makes it difficult to discern any objects of interest; the thermal image on the right is not affected by the bright sun and therefore provides detail and contrast.

The PTZ-35/-50 MS is designed to be compatible with standard security systems employing ordinary daylight cameras. A variety of connection options are available. Each system includes a standard breakout cable that allows connection to power, analog video (one output for the thermal camera and one for the standard video camera) and control (RS-232 and RS-422 are provided, with only one or the other useable at any given time, depending on the configuration ordered).

2.2 Package Contents

Refer to the Shipping Check List that is shipped with each camera for a description of the parts and components that are included with the camera. If there is any discrepancy between the list and the contents of your shipment, please contact FLIR Systems Customer Support immediately using the contact information at the front of this manual.



Figure 4: PTZ-35 MS / PTZ-50 MS camera foot and mounting bracket shoe



Figure 5: Quick Connect Interface Cable w/ break-out pigtail shown at bottom insert

3.0 QUICK-START INFORMATION

The following instructions will get you started with basic operation of the PTZ-35 MS / PTZ-50 MS.

1. Firmly secure mounting bracket shoe to designated frame or structure able to support and allow for device travel.
2. Insert camera head foot into the mounting bracket shoe as shown in Figure 4 being careful to align the pin side of camera head before sliding into shoe. Depress release button on side to fit.
3. Next, tighten tamper resistant set screw to secure camera in place. Screw is shown on far right side of Figure 4.
4. Remove any lens cap. (Remember to replace the lens cap when the cameras are not in use to prevent accidental scratching and dust contamination.)
5. Attach the other end of the sealed interface cable to the break-out pigtail.
6. Plug a standard RCA video cable into the connection labeled "DLTV" on the break-out pigtail for the daylight camera.
7. Plug a standard RCA video cable into the connection labeled "Infrared" on the break-out pigtail for the infrared camera.
8. If the camera model supports RS-232 communications and you intend to use the User Interface software for remote control of the device, attach a standard RS-232 cable to the connection labeled "RS-232" on the break-out pigtail. Connect the other end of the RS-232 cable to an available COM port slot on the PC. (Be sure to note the COM port number for communication settings!)
9. Plug the AC/DC converter into an electrical outlet. Insert the circular plug of the power converter to the connection labeled "POWER" on the break-out pigtail.
10. Now the PTZ-35 MS / PTZ-50 MS camera is ready for use. Note that the device will immediately zero itself and return back to home position upon applying power.

You have now completed the basic steps for setup of the PTZ-35 MS / PTZ-50 MS. However, it is recommended that you read the rest of this User's Manual to learn how to adjust the PTZ-35 MS / PTZ-50 MS system settings according to your preferences.

4.0 PTZ-35 MS / PTZ-50 MS USER INTERFACE

The User Interface provides the basic pan/tilt control, the infrared camera control and the daylight camera control as well as communication settings. It also provides an indicator showing read/write confirmation to the infrared camera after each command in the lower-right corner. Detailed descriptions for using these controls are described herein.



Figure 6: PTZ-35 MS / PTZ-50 MS User Interface

Communication Panel The Communication Panel tab, shown in Figure 6, is located on the left-side of the About tab. The PTZ-35 MS / PTZ-50 MS can communicate at the 2400, 4800, 9600 & 57600 baud rates and both pan/tilt as well as camera control can be accessed. To access the device, simply choose the camera control switch and select the correct COM port that is connected to your PC. Once the correct COM port has been selected then communication can proceed. Note that selecting the Pelco address will only configure the GUI and not change the device address itself.

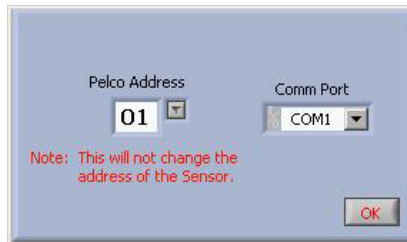

Figure 7: Select COM Port and Pelco Address

If you are having trouble communicating with the device, be sure to check **all** connections and confirm the COM port selection at the PC and the device. Also, confirm the standard RS-232 cable is a working cable and not faulty.

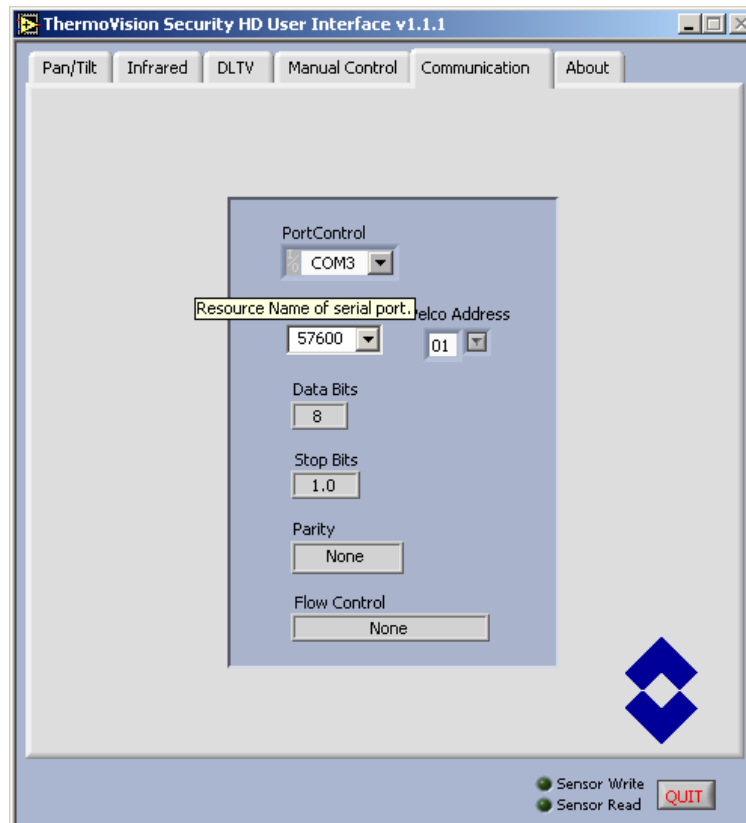

Figure 8: PTZ-35 MS / PTZ-50 MS Communication panel

Note the following:

- If Baud Rate is set to the slower values (2400 or 4800), some GUI commands (Get FPA Temp, Get Version, Get Serial Number, etc) may not function properly due to the delays in reading and writing the long command packets. It is recommended to use the fastest baud rate possible.
- The GUI will have an easier time connecting to the PTZ-35 MS / PTZ-50 MS if the hardware is powered up prior to opening the software.
- It is extremely important for the operator to know the Pelco address of the PTZ-35 MS / PTZ-50 MS . If only one device is in use, it is recommended to keep the address at the default setting (01). If the address is lost or forgotten, the operator will have to manually search through the range of values (01-99).
- Pelco address 08 is reserved for internal use by the PTZ-35 MS / PTZ-50 MS and cannot be used anywhere else in the network.

Pan/Tilt Panel The Pan/Tilt panel, shown in Figure 9, provides the ability to control the azimuth and elevation mechanism along with preset locations for the PTZ-35 MS / PTZ-50 MS.

Pan/Tilt Drive: provides pan/tilt direction and positioning

1. Presets. The preset buttons allow the user to set/get 3 preset locations and determine the home location. These presets are valid or stored in memory for as long as the User Interface software application is running. The Import/Export buttons allow the user to store and load preset locations.
2. Direction. The direction allows the user to drive the pan/tilt up, down, right, left, up-right, up-left, down-right, down-left and home.
3. Pan Speed. The pan speed increments the speed for the azimuth from slowest (left side) to the fastest (right side) using the slider arrow.
4. Tilt Speed. The tilt speed increments the speed for the elevation from slowest (left side) to the fastest (right side) using the slider arrow.

Manual Control: provides discrete pan/tilt azimuth and elevation input

1. Azimuth. The azimuth can be set as an absolute position between 0 and 550
2. Elevation. The elevation can be set as an absolute position between 0 and 190

Also, an elevation display dial and azimuth display dial are used to indicate current positions.

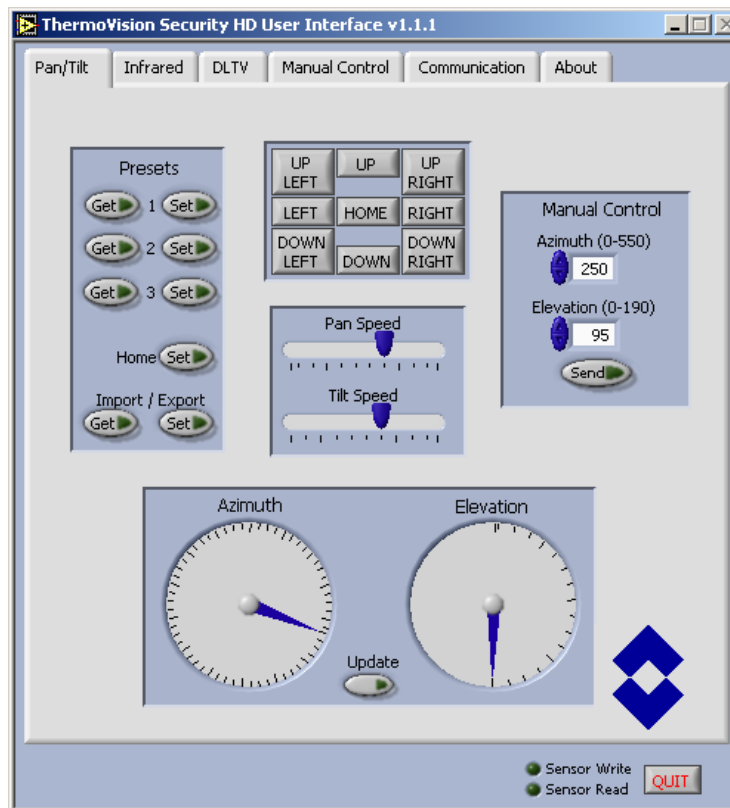

Figure 9: PTZ-35 MS / PTZ-50 MS Pan/Tilt panel

Infrared Panel The Infrared panel contains the **Video and AGC** tab and a **General** tab, shown in Figure 10 and Figure 11. These tabs provide the ability to control the infrared camera from the PC. The **Video and AGC** tab provides for basic image optimization along with camera control. The **General** tab allows for further camera control to set power-on defaults and get further camera data. The infrared camera commands for the PTZ-35 MS / PTZ-50 MS software interface are listed in section 9.0 Software Control Functions.

Video and AGC: provides infrared camera video and AGC settings

1. Polarity. Imagery can be displayed in either white-hot (hotter objects appear brighter than cooler objects) or black-hot (hotter objects appear darker than cooler objects).
2. FFC. The infrared camera includes an internal shutter for periodically improving image quality via a process called “flat-field correction” (FFC). During an FFC, a small calibration flag rotates in front of the detector array, presenting a uniform temperature (i.e. a “flat field”) to every detector element. Auto mode performs the FFC based on a change in ambient temperature and Manual mode only performs the FFC when input by the user. Both modes allows for an instantaneous FCC by depressing the “Do FFC” button.
3. Electronic Zoom. The camera will perform a 2X zoom controlled by the user.
4. AGC Type. The image can be optimized using an Automatic Gain Control or AGC type algorithm. The three AGC types available are Plateau Equalization, Linear Histogram and Logarithmic. Definitions for each are described below.
 - a. Plateau Equalization: The plateau equalization uses a histogram equalization algorithm (HEQ) to analyze the scene content in real time and redistributes the dynamic range of the scene.
 - b. AutoBright: The auto bright algorithm allows for the contrast and brightness bias to be set while maintaining the offset automatically.
 - c. Linear Histogram: The linear histogram algorithm uses scene statistics to set a global linear gain and offset (contrast and brightness) for the image.
 - d. Manual: The manual setting allows for user control for contrast (gain) and brightness (offset) for the image.
5. AGC Parameters. The image can be further optimized using the AGC Parameters to control the Plateau Value, Mid ITT Offset and Max Gain. All of these terms allow the user to optimize the image based on the scene content.
6. Region Of Interest. The Region Of Interest or ROI determines what portion of the screen will be used for the AGC calculations. The Full Screen option applies the AGC algorithm based on scene content on the full screen. The Horizon Optimized applies horizontally across the screen but uses only the middle third in the vertical direction. The Sky Optimized applies horizontally across the screen but only the top half in the vertical direction. The Ground Optimized applies horizontally across the screen but on the lower half in the vertical direction. The other modes are applied using the center of the screen as 0, 0.
7. Detail Enhancement. This option applies a Bi-Lateral filter to enhance the image. The default values are 16, 24, 32, 64, 96 and 128.

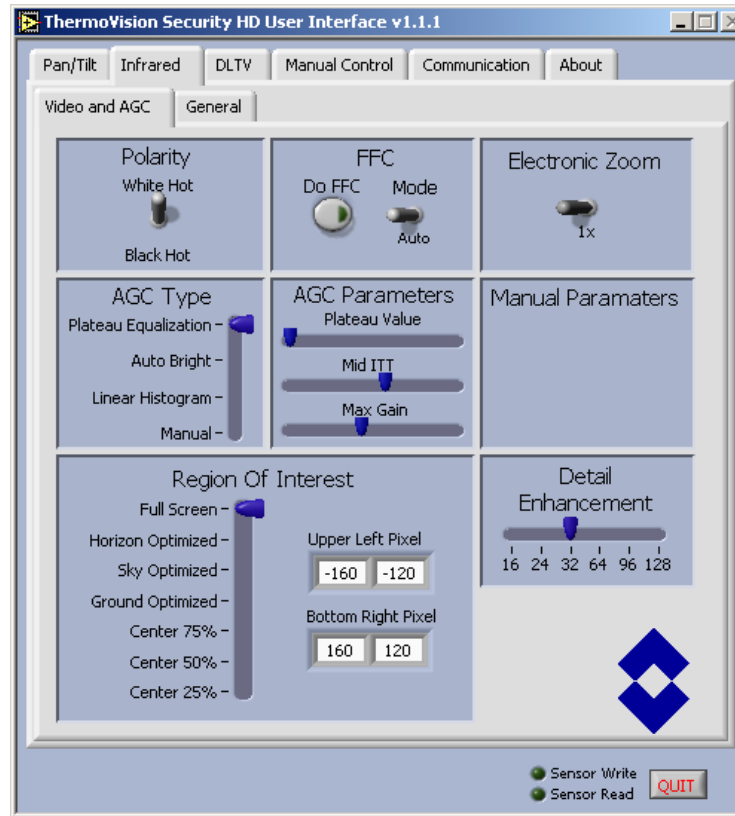

Figure 10: PTZ-35 MS / PTZ-50 MS Infrared panel

General: provides the user to save the default settings and monitor sensor or FPA temp

1. FPA Temperature. This command gets the FPA or sensor temperature and displays in degrees C. The FPA Temperature can also be monitored by depressing the "Monitor FPA Temp?" button.
2. No-Op. The No-Op command sends a non-operational command to the infrared camera. This can be used to verify camera connectivity.
3. Reset Camera. The Reset Camera command causes the infrared camera to reboot.
4. Set Power-on Defaults. This command will save the image optimization and other settings into the camera to use upon start-up.
5. Restore Factory Defaults. This command will restore the infrared camera to its factory set defaults.
6. Array Size. The array size only effects the ROI settings based on either the Photon Block 1 (320x120) or Photon Block 2 (320x240).
7. Get S/N and Get Version. These commands will return the infrared camera serial number and the software/FPGA versions.

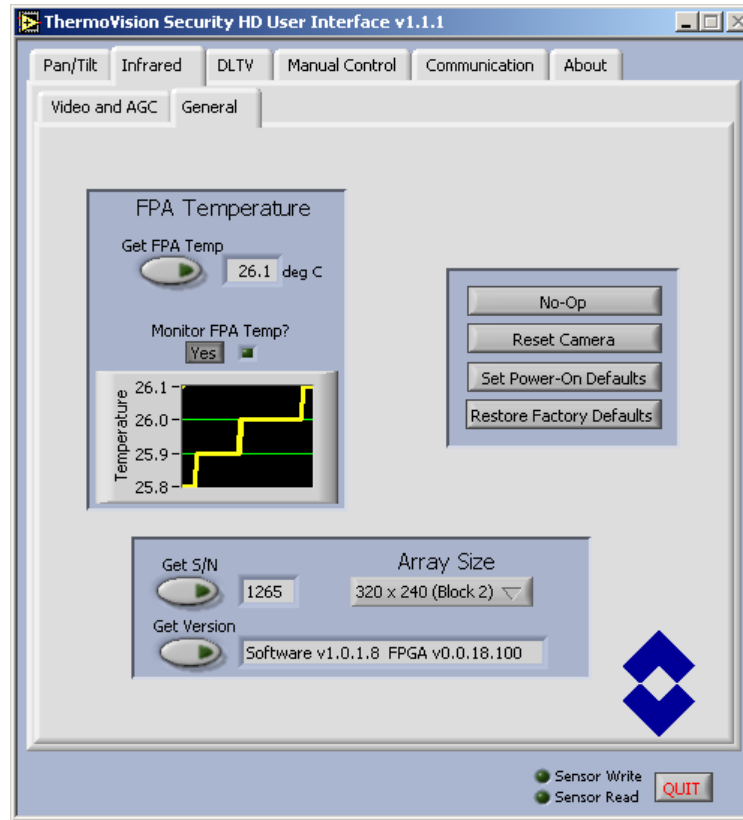

Figure 11: PTZ-35 MS / PTZ-50 MS Infrared panel

DLTV Panel The DLTV panel contains the daylight camera settings as shown in the Figure 12. These commands provide the ability to control the daylight camera from the PC.

Zoom: provides the user to control the daylight camera zoom and focus.

1. Optical Zoom In/Out. These commands allow the user to zoom in/out the daylight camera.
2. Digital Zoom On/Off. These commands allow the user to turn on/off the digital zoom.
3. Slow/Fast Slider. This slider allows the user to input the speed of the zoom from slow to fast.
4. Focus Mode. This command allows for either manual focus or auto focus of the daylight camera.
5. Focus Near. This command allows the user to focus at objects that are near when in manual mode.
6. Focus Far. This command allows the user to focus for far away objects when in manual mode.
7. One-Shot. This command allows the user to auto focus on the objects once with this button when in manual mode.

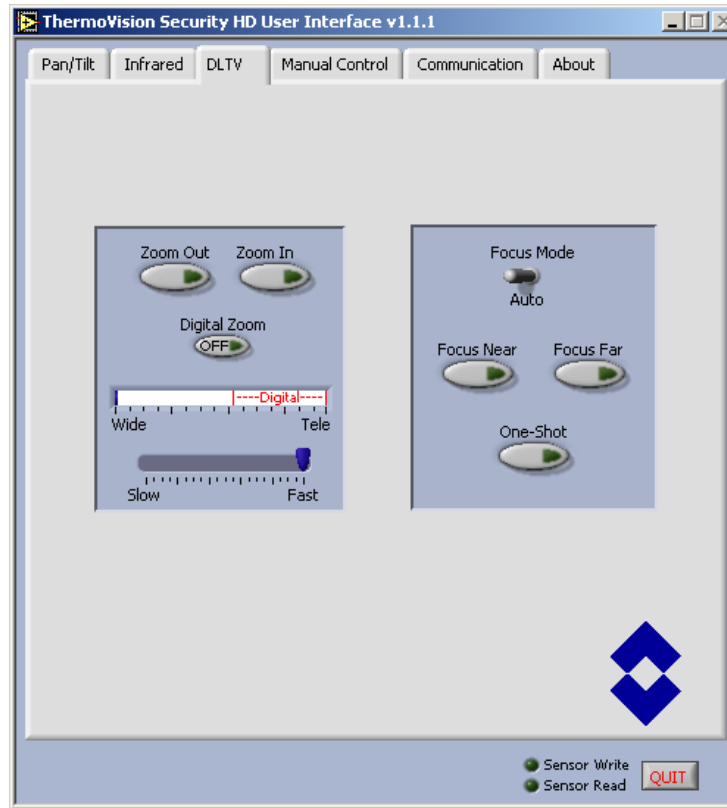

Figure 12: PTZ-35 MS / PTZ-50 MS DLTV panel

Manual Control Panel The Manual Control panel, shown in Figure 13, allows the user to manually send command words to control the pan/tilt, the infrared camera and the daylight camera. Also, view the system response command word.

Write: provides the user to send hex commands the device for control.

1. Send. Enter the appropriate hex command and this will send the command to the device.
2. Reset. This will reset the entry to all zeros.

A list of commands is in Section 9.0 Software Control Functions. For a complete list of the commands refer to the PTZ-35 MS / PTZ-50 MS Software Interface Control Document or ICD 102-1270-151.

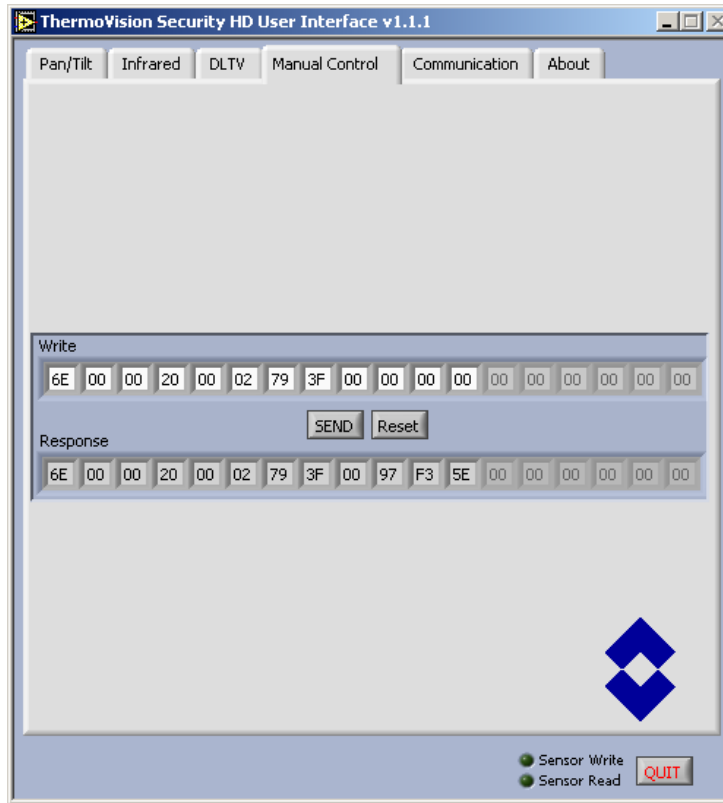

Figure 13: PTZ-35 MS / PTZ-50 MS Manual Control

5.0 PTZ-35 MS / PTZ-50 MS PHYSICAL INTERFACE

Dimension Drawings The following figures show a dimensional drawing of the PTZ-35 MS / PTZ-50 MS.

Remember to firmly secure the unit and allow for device travel (pan and tilt).

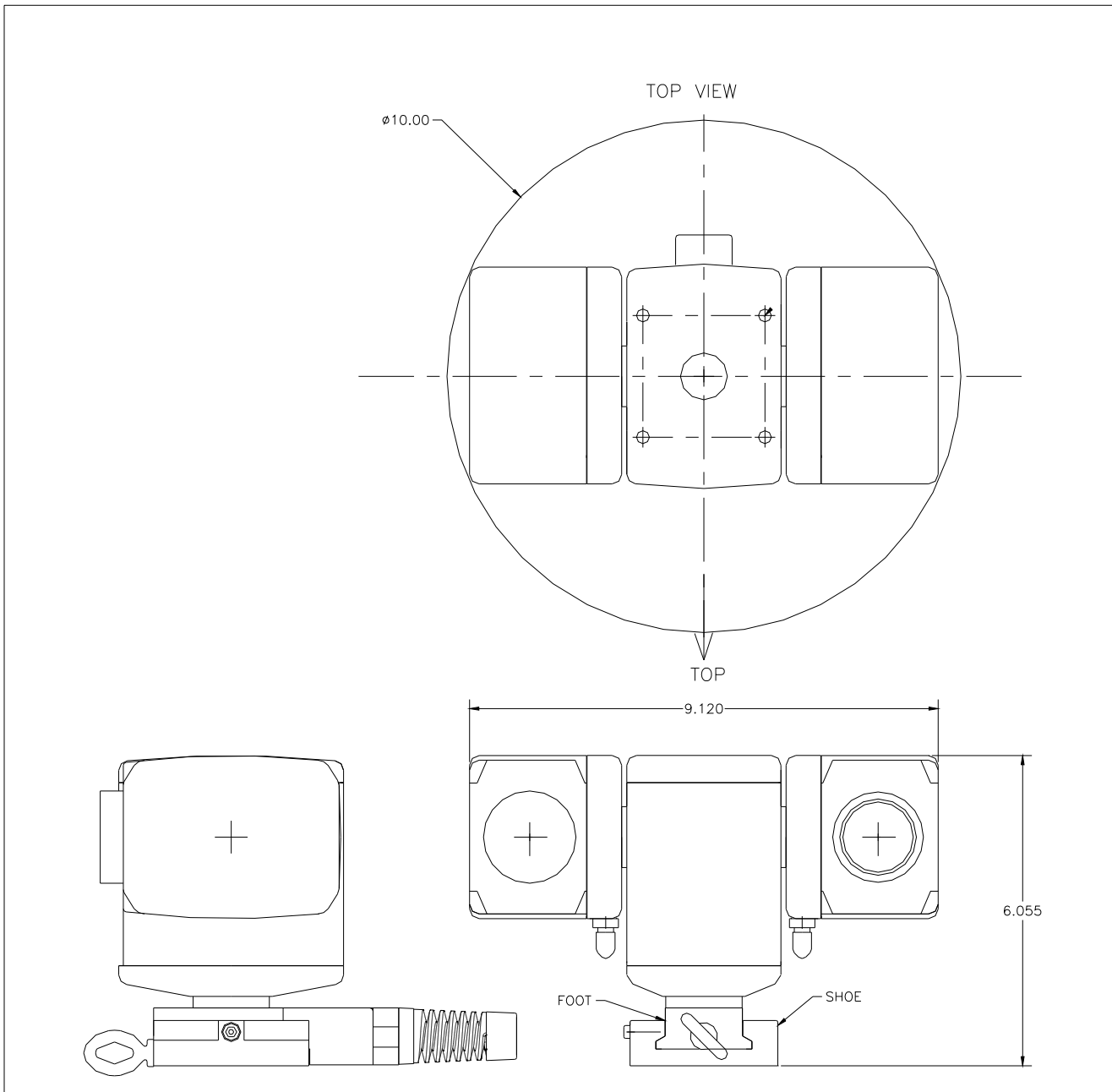

Figure 14: PTZ-35 MS / PTZ-50 MS Dimension Drawing

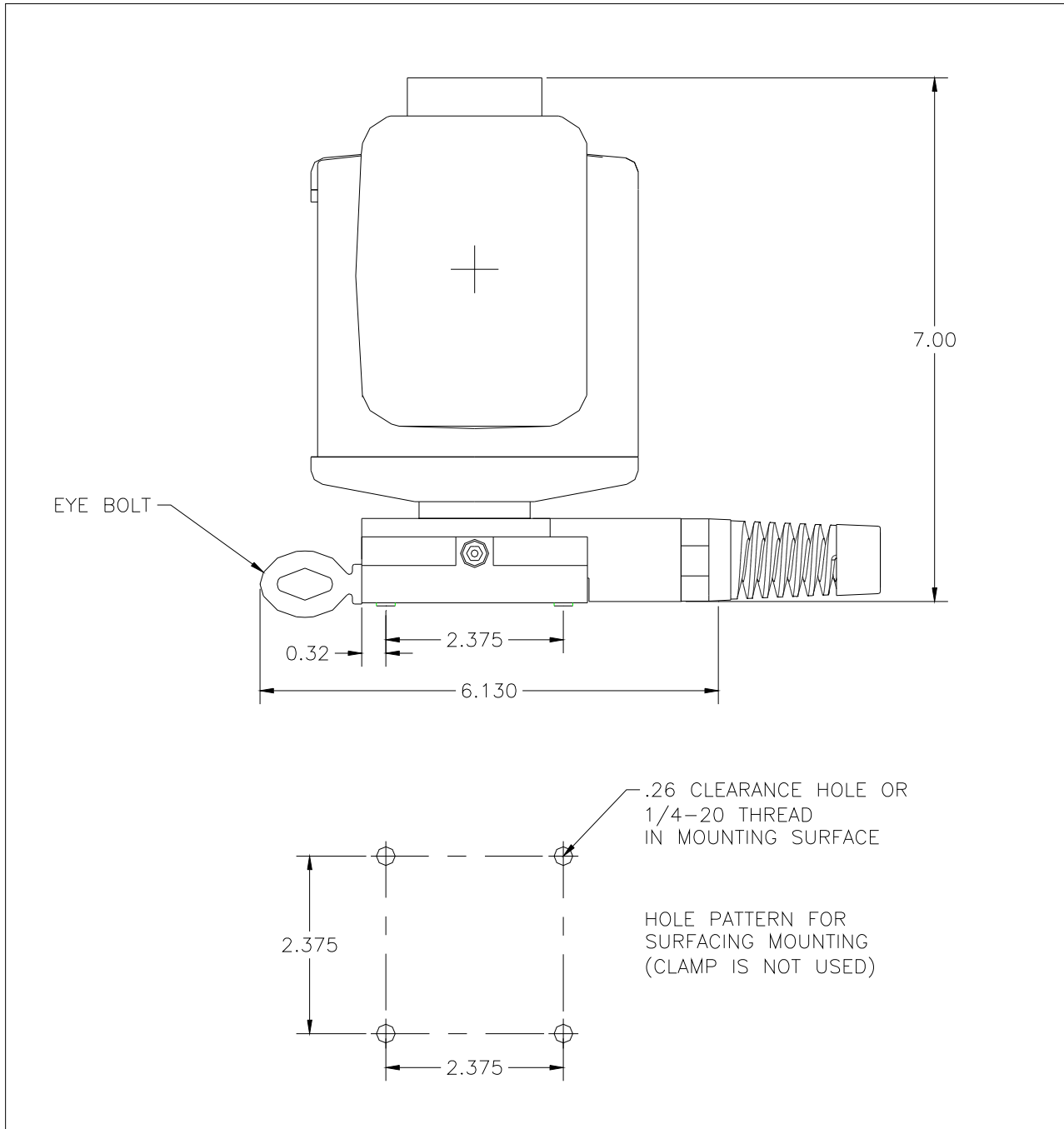
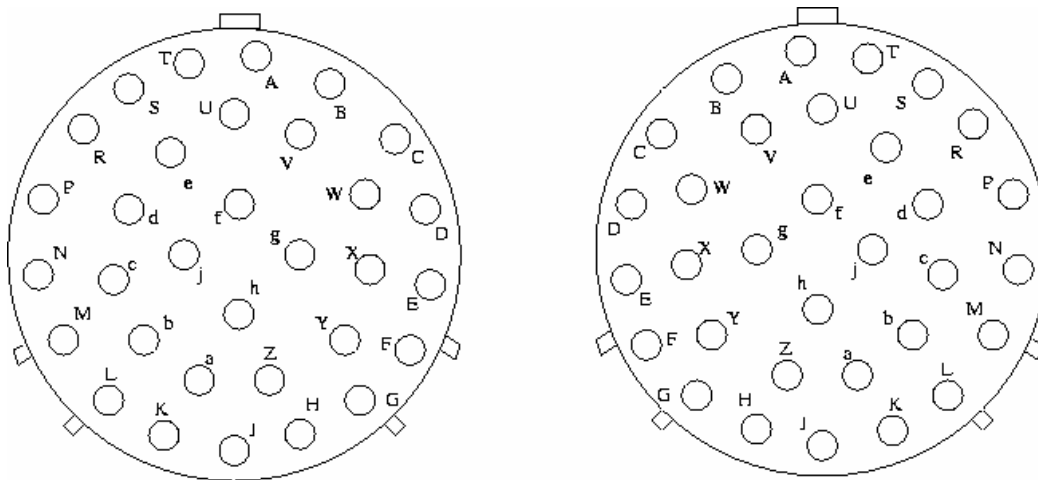

Figure 15: PTZ-35 MS / PTZ-50 MS Dimension Drawing with hole pattern

Integrated Interface Cable Connector The PTZ-35 MS / PTZ-50 MS uses an electrical-mechanical engagement system that requires only one integrated cable to interface with the sensor. The interface cable is 12.5 meters (± 0.5) long and is terminated with a MIL-C-26482 Series 1 Connector (Male). The table below describes the specifications:

MIL-C-26482 Series 1	
Shell Size	18
Insert Arrangement	32
Finish	Olive drab chromate over cadmium
Contacts	Pines
Shell Style	Cable plug
Insert Position	Keyring



Interface cable connector front view (Male)

Chassis connector front view (Female)

Figure 16: PTZ-35 MS / PTZ-50 MS Interface Cable Connector

Function	Pin	Signal Name	Function	Pin	Signal Name
Power	j	VDC1	Comms	N	Tx RS-232 (COM1)
	b	VDC1 RTN		M	Rx RS-232 (COM1)
	f	VDC2		c	GND RS-232 (COM1)
	h	VDC2 RTN		A	Tx (-)RS-422 (COM3)
	g	VDC3		T	Rx (-)RS-422 (COM3)
	Z	VDC3 RTN		U	Tx (+)RS-422 (COM3)
			S	Rx (+)RS-422 (COM3)	
			Video	K	Video 1
				L	Video 1 Shield
				H	Video 2
				J	Video 2 Shield

Break-Out Connector Cable

The PTZ-35 MS / PTZ-50 MS also include a break-out cable (as shown in **Figure 5**) that connects to the integrated interface cable with single terminal connectors. The break-out cable has the MIL-C-26482 Series 1 Connector (Female) on one end and five pig-tail leads of the following:

Input voltage range: 24 VDC \pm 10 % with 24 VDC optimum value

Pin 1: +Power input
Pin 2: Power return
Pin 3: Chassis ground

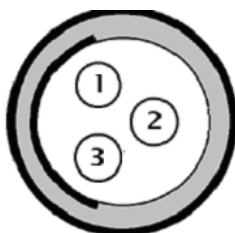

Power Supply Connector (Male)

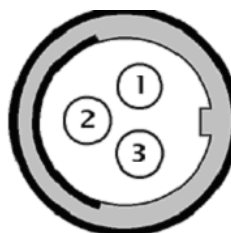

Break-Out Connector (Female)

Figure 17: Fisher 103-A032 (Female) on Break-Out Connector

Two leads are for the IR and DLTV video as shown here:

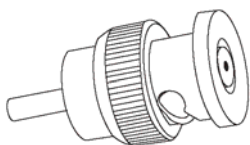

Figure 18: IR Video Output

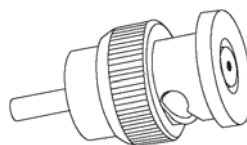

Figure 19: DLTV video output

Finally, two leads for communication as shown here:

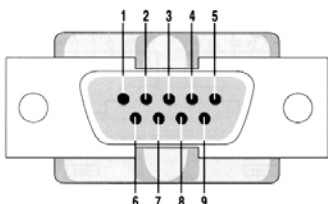

Figure 20: RS-232 DB-9 (Female)

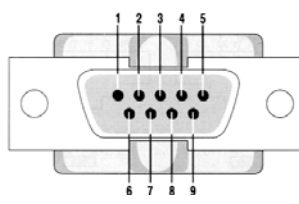

Figure 21: RS-422 DB-9 (Male)

RS-232 DB9 Socket	
COM 1 Tx	Pin 2
COM 1 Rx	Pin 3
COM 1 GND	Pin5

RS-422 DB9 Pin	
COM 3 Tx (+)	Pin 8
COM 3 Tx (-)	Pin 9
COM 3 Rx (+)	Pin 6
COM3 Rx (-)	Pin 7
Note: With RS-422 communications, the transmit (Tx) connections from the camera go to the receive (Rx) connections at the other end, and vice versa.	

6.0 MAINTENANCE

6.1 Lens Cleaning

Materials:

- Optical-grade tissue (e.g., Edmund Industrial Optics part number 52105 or any similar product)
- pure water (de-ionized or other)
- isopropyl alcohol (IPA)

Procedure:

1. Saturate a piece of the lens tissue with the water and drape it over the lens. Let the surface tension of the water pull the tissue onto the lens surface and then drag the tissue across the lens surface. Repeat several times with different pieces of tissue.
2. Repeat the same step using IPA instead of water. Drag the final piece of tissue over the lens several times to prevent pooling, which could leave a residue behind.

7.0 PTZ-35 MS / PTZ-50 MS SPECIFICATIONS

- Power/Weight :

Input Voltage Range:	24 VDC \pm 10 %
Sensor Weight w/o cable:	3628 g (8 lbs)

- Pan/Tilt Specifications:

	Azimuth	Elevation
Motion Range (°)	\pm 200	\pm 60
Angular Velocity (°/sec)	1 to 80	1 to 40
Resolution (°)	0.5	0.5
Accuracy (°)	1.0, 1 σ	1.0, 1 σ

- DLTV Camera Specifications:

- Array >800,000 pixels (PAL) and >680,000 pixels (NTSC)
- FOV Horizontal 45° to 2°, Optical
- Focus Automatic
- Iris Automatic
- Shutter Automatic
- Balance Automatic
- IR cut filter Automatic
- Image Stabilization 5 to 75 Hz, <1gm.
- Digital Zoom 12X
- Spectral Response 400 to 750 nm with IR cut filter

- Infrared Camera Specifications:

	Wide FOV 30 mm	Narrow FOV50 mm
Focal Plane Array	Uncooled microbolometer	Uncooled microbolometer
Format	320 x 240	320 x 240
Pixel Size	38 μ m	38 μ m
Aperture	f/1.6	f/2.0
Field of View	23° HFOV x 11° VFOV	14° HFOV x 5° VFOV
IFOV	1.26 mrad	0.76 mrad
Focus	Manual	Manual
Temporal NEdT	50 mK < btw <85 mK	50 mK < btw <85 mK
Range	400 meters	700 meters

- Frame Rate 30 Hz
- Spectral Response 7.5 μ m to 13.5 μ m

- Turn-on time: ≤ 4 sec above -10°C (14°F)
 ≤ 75 sec at -40°C (-40°F)
- Image Boresight Requirements – The visible image shall be aligned with the IR image to within 10% of the equivalent IR FOV.
- Environmental Requirements:
Caution: Sustained storage at high-temperature will degrade vacuum life of the camera core.
 - Storage Temperature -50°C to $+85^{\circ}\text{C}$
 - Operating Temperature -32°C to $+55^{\circ}\text{C}$
 - Moisture IP-X6
 - Sand/Dust MIL-STD-810E, Method 510.3, procedure II
 - Vibration MIL-STD-810E, Method 514.4
 - Shock (transportation) 30g, 11 msec.
 - EMI/EMC
 - CE
 - FCC
 - Solar Thermal Loading MIL-STD-810E, Method 505.3, procedure I, paragraph 1 3.2.b1
 - External Icing MIL-STD-810E, Method 521.1, 6 mm ice thickness
 - Wind Load 35 mph

Note: These specifications are subject to change without notice.

8.0 OPTIONAL JOYSTICK DISPLAY UNIT

8.1 Joystick Control w/ Display Unit

The Joystick Display Unit, also called the LOOK display controller, is shown below in Figure 22.



Figure 22: Joystick Display Unit

The operation directions for the Joystick Display Unit can also be found on the back of unit. An example of this is shown in Figure 23.

Joystick operation: When pushed left or right, forward (up) or back (down), the camera moves in that direction. When twisted clockwise, the camera zooms in; zooming in lowers the pan/tilt speed in three steps. When twisted counterclockwise, the camera zooms out; zooming out increases the pan/tilt speed. The top two white buttons (GEAR) are used to set the maximum speed manually.

Low Light Toggle On/Off (DISPLAY) “LO” button the GREEN LED will flash quickly. This mode applies a slow shutter & the motion will be blurred.

Vibration Press & hold YELLOW 2ND button & press (DISPLAY) “HI” – the top GREEN LED will flash slowly & the Vibration should decrease.

Tips: When zooming place target in center of display, then zoom. Use “Stabilize Image” when vehicle is in motion –see Vibration above.

Joystick drift: If the camera moves or zooms without touching the joystick, this is called “drift”. Follow these instructions to correct the problem:

1. Recycle power without touching joystick during the flashing LED portion of the turn-on sequence.
2. To recalibrate the joystick:
 - a. Remove power.
 - b. Depress and hold the ‘Gear – DN’ white button (top right).
 - c. Apply power.
 - d. Wait 10 seconds and release button.

Caution: The unit should be operated by a person other than the driver while vehicle is in use. When not in use, remove power jack from Joystick Display Unit.

BUTTON DEFINITION	SECOND FUNCTION DEFINITION Hold Down '2nd' While Depressing Button
AutoFocus On/Off <input type="checkbox"/> <input type="checkbox"/> UP <input type="checkbox"/> DN JoyStick Gearing or Preset Scan Speed	AutoFocus On/Off <input type="checkbox"/> <input type="checkbox"/> UP <input type="checkbox"/> DN PreSet Interval Time Between GoTo's.
NIR <input type="checkbox"/> M <input type="checkbox"/> Near <input type="checkbox"/> <input type="checkbox"/> 1 <input type="checkbox"/> 2 1-GoTo Preset 1 2-GoTo Preset 2	NIR Lamp <input type="checkbox"/> M <input type="checkbox"/> <input type="checkbox"/> 1 <input type="checkbox"/> 2 1-Set PreSet 1 2-Set PreSet 2
AutoFocus ON ● Second Function <input type="checkbox"/> 2nd <input type="checkbox"/> Far <input type="checkbox"/> HI <input type="checkbox"/> LO HI-BackLight LO-SlowShutter	Second Function <input type="checkbox"/> <input type="checkbox"/> HI <input type="checkbox"/> LO HI-Stablize Image LO-Spare
GO TO PRESET - Press 1 or 2 SCAN BETWEEN PRESETS: Press UP or DN to change speed. Press '2nd'+ UP or DN to change period Start Scan - Press Both 1 and 2 Stop Scan - Move Joystick	SETTING PRESETS: Point and Zoom to Location 1, Press '2nd' + 1 Point and Zoom to Location 2, Press '2nd' + 2
IF PAN OR TILT DRIFT - Hold DN Button at Power On for 10 Seconds. JoyStick Calibration - DO NOT TOUCH JOYSTICK	

Figure 23: Operational Directions on back of Joystick Display Unit

9.0 SOFTWARE CONTROL FUNCTIONS

9.1 Software Interface Description

The Sensor software interface is accomplished across a single hardware communications channel. This channel is factory selectable to be either RS-422 or RS-232. The channel baud rate is set at 2400k, 9600k. This channel carries command/status data for all three devices; IR Imager, visible imager and the pan/tilt mechanism.

The RS-232 configuration is as follows:

Baud Rate	9600
Data Bits	8
Parity	None
Stop Bits	1
Flow Control	None

9.2 IR Imager

This section describes the structure of the commands of the IR imager on the PTZ-35 MS / PTZ-50 MS. Note that all data values are called out in hexadecimal. The command and response strings of the IR imager interface are of variable length, ranging from 10 bytes to 32 bytes. The byte descriptions are as follows:

Byte 1	Process Code
Byte 2	Status
Byte 3	Reserved
Byte 4	Function Code
Byte 5	Data Byte Count (MSB)
Byte 6	Data Byte Count (LSB)
Byte 7	CRC 1 (MSB)
Byte 8	CRC 1 (LSB)
Byte	Data Byte i (first byte)
	...
	{Variable, 0 to 22 data bytes total}
Byte	Data Byte j (last Byte)
Byte _n	CRC 2 (MSB)
Byte _{n+1}	CRC 2 (LSB)

where: $n = 8 + \text{Data Byte Count}$

Examples: If data byte count = 0, total string bytes = 10
 If data byte count = 8, total string bytes = 18

IR Imager Status Byte

The status byte (Byte 2) of all commands to the IR Imager should, under normal operating conditions, contain 00_H. For all responses, the thermal imager will set the status byte in accordance with the following table:

Status Byte Value (hex)	Definition	Description
0x00	CAM_OK	Function executed
0x01	CAM_BUSY	Camera busy processing serial command
0x02	CAM_NOT_READY	Camera not ready to execute specified serial command
0x03	CAM_RANGE_ERROR	Data out of range
0x04	CAM_CHECKSUM_ERROR	Header or message-body checksum error
0x05	CAM_UNDEFINED_PROCESS_ERROR	Unknown process code
0x06	CAM_UNDEFINED_FUNCTION_ERROR	Unknown function code
0x07	CAM_TIMEOUT_ERROR	Timeout executing serial command
0x09	CAM_BYTE_COUNT_ERROR	Byte count incorrect for the function code
0x0A	CAM_FEATURE_NOT_ENABLED	Function code not enabled in the current configuration.

IR Imager Commands / Responses:

Command	Value	Command Word	System Response	Notes
No-Op		6E000000000DFBB0000	6E000000000DFBB0000	
Set Camera Defaults		6E0000010000EB8B0000	6E0000010000EB8B0000	
Reset Factory Defaults		6E000003000086EB0000	6E000003000086EB0000	
Get Serial Number		6E0000650000AF200000	6E0000650004EFA4000(aabbccdd)0E	S/N aabbccdd
Get Version		6E0000050000344B0000	6E0000050008B543(abcdefghijklmnp)0DF7	Software ab.cd.ef.gh FPGA ij.kl.mn.op
Set FFC Mode				
Auto		6E00000B00020F0800000000	6E00000B00020F0800000000	
Manual		6E00000B00020F0800011022	6E00000B00020F0800011022	
Do FFC		6E00000C0000AADA0000		
E-Zoom				
1x		6E00000F0002D3C800000000	6E00000F0002D3C800000000	

2x		6E0000F0002D3C800044084	6E0000F0002D3C800044084	
Video Polarity				
White-Hot		6E0000100002BC9A00000000	6E0000100002BC9A00000000	
Black-Hot		6E0000100002BC9A00011021	6E0000100002BC9A00011021	
AGC Type				
Plateau Equalization		6E0000130002E5CA00000000	6E0000130002E5CA00000000	
Linear Histogram		6E0000130002E5CA000550A5	6E0000130002E5CA000550A5	
Logarithmic		6E0000130002E5CA000660C6	6E0000130002E5CA000660C6	
Command	Value	Command Word	System Response	Notes
Get FPA Temp		6E0000200002793F00000000	6E0000200002793F(abcd)XXXX	ab cd Hex Deg C XXXX is CRC 2
Shutter Position				
Open		6E0000790002B96000000000	6E0000790002B96000000000	
Closed		6E0000790002B96000011021	6E0000790002B96000011021	
Set Max Gain				
	2	6E00006A0002A3529302202	6E00006A0002A3529302202	
	3	6E00006A0002A35300033063	6E00006A0002A35300033063	
	4	6E00006A0002A35300044084	6E00006A0002A35300044084	
	5	6E00006A0002A353000550A5	6E00006A0002A353000550A5	
	6	6E00006A0002A3530660C6	6E00006A0002A3530660C6	
	7	6E00006A0002A35000770E7	6E00006A0002A35000770E7	
	8	6E00006A0002A3500088108	6E00006A0002A3500088108	
	9	6E00006A0002A35300099129	6E00006A0002A35300099129	
	10	6E00006A0002A353000BB16B	6E00006A0002A353000BB16B	
	11	6E00006A0002A353000CC18C	6E00006A0002A353000CC18C	
	12	6E00006A0002A353000DD1AD	6E00006A0002A353000DD1AD	
	13	6E00006A0002A353000EE1CE	6E00006A0002A353000EE1CE	
	14	6E00006A0002A353000FF1EF	6E00006A0002A353000FF1EF	
	15	6E00006A0002A35300101231	6E00006A0002A35300101231	
Set ROI Size				
Full Screen		6E00004C0008367FFF60FFC400A0003C8317	6E00004C0008367FFF60FFC400A0003C8317	
Horizon Optimized		6E00004C0008367FFF60FFE200A0001E4206	6E00004C0008367FFF60FFE200A0001E4206	
Sky Optimized		6E00004C0008367FFF60FFC400A0000074C8	6E00004C0008367FFF60FFC400A0000074C8	
Ground Optimized		6E00004C0008367FFF60000000A0003C6D16	6E00004C0008367FFF60000000A0003C6D16	
Center 75%		6E00004C0008367FFF88FFD30078002DA5F2	6E00004C0008367FFF88FFD30078002DA5F2	
Center 50%		6E00004C0008367FFFB0FFE20050001EE03A	6E00004C0008367FFFB0FFE20050001EE03A	
Center 25%		6E00004C0008367FFFD8FFF10028000F59BC	6E00004C0008367FFFD8FFF10028000F59BC	
Set Detail Enhancement				
	10	6E0000D30008627700003090106400043967	6E0000D30000E37F0000	

	20	6E0000D3000862770000309020640004158E	6E0000D30000E37F0001	
	30	6E0000D300086277000030903064000422C0	6E0000D30000E37F0002	
Photon Reboot		6E0000020000B1DB0000	6E0000020000B1DB0000	
Plateau Value				
	0			
	100	6E00003F0002166D00000000	6E00003F0002166D00000000	
	200	6E00003F0002166D00642C22	6E00003F0002166D00642C22	
	300	6E00003F0002166D00C85844	6E00003F0002166D00C85844	
	400	6E00003F0002166D012CDFD6	6E00003F0002166D012CDFD6	
	500	6E00003F0002166D0190B088	6E00003F0002166D0190B088	
	600	6E00003F0002166D0258BD9F	6E00003F0002166D0258BD9F	
	700	6E00003F0002166D02BC0035	6E00003F0002166D02BC0035	
	800	6E00003F0002166D03207131	6E00003F0002166D03207131	
	900	6E00003F0002166D0384845F	6E00003F0002166D0384845F	
	1000	6E00003F0002166D03E82975	6E00003F0002166D03E82975	
Command	Value	Command Word	System Response	Notes
Mid ITT Offset				
	10	6E00005500024AC7000AA14A	6E00005500024AC7000AA14A	
	20	6E00005500024AC7001452B5	6E00005500024AC7001452B5	
	30	6E00005500024AC7001EF3FF	6E00005500024AC7001EF3FF	
	40	6E00005500024AC70028A56A	6E00005500024AC70028A56A	
	50	6E00005500024AC700321611	6E00005500024AC700321611	
	60	6E00005500024AC7003CF7DF	6E00005500024AC7003CF7DF	
	70	6E00005500024AC700462802	6E00005500024AC700462802	
	80	6E00005500024AC700505AF5	6E00005500024AC700505AF5	
	90	6E00005500024AC7005AFBBF	6E00005500024AC7005AFBBF	
	100	6E00005500024AC700642C22	6E00005500024AC700642C22	
	110	6E00005500024AC7006E8D68	6E00005500024AC7006E8D68	
	125	6E00005500024AC7007DAF3A	6E00005500024AC7007DAF3A	

9.3 Daylight Camera

This section describes the structure of the commands of the daylight camera on the PTZ-35 MS / PTZ-50 MS Sensor. Note that all data values are called out in hexadecimal. The command and response strings of the daylight camera interface are of variable length, ranging from 5 to 32 bytes. The format for these command / response strings differs from the IR Imager in that the number of data bytes is not included in the string. Rather the word is terminated by an "End-Of-Word" byte. The byte descriptions are as follows:

- Byte 1 Process Code (8 plus the Pelco Address) ie. 81 is Pelco 01
- Byte 2 Read / Write
- Byte 3 Device
- Byte 4 Function Code

Byte Data Byte i (first byte)
 ... {Variable, 0 to 27 data bytes total}
 Byte Data Byte j (last Byte)
 Byte_n End Of Word

where: n = 5 + Number of Data Bytes

Visible Imager Commands/Responses:

Command	Command Word	System Response	Notes
Zoom			
In	81 01 04 07 2Z FF	90 41 FF 90 51 FF	Z=Speed, 2-7
Out	81 01 04 07 3Z FF	90 41 FF 90 51 FF	
Stop	81 01 04 07 00 FF	90 41 FF 90 51 FF	
Get Zoom Position	81 09 04 47 FF	90 50 0Z 0Z 0Z 0Z FF	ZZZZ = Position LSB = 0.5 deg.
Focus			
Near	81 01 04 08 2Z FF	90 41 FF 90 51 FF	Z=Speed, 2-7
Far	81 01 04 08 3Z FF	90 41 FF 90 51 FF	
Stop	81 01 04 08 00 FF	90 41 FF 90 51 FF	
Focus			
Auto	81 01 04 38 02 FF	90 41 FF 90 51 FF	
Manual	81 01 04 38 03 FF	90 41 FF 90 51 FF	
One-Shot Focus	81 01 04 18 01 FF	90 41 FF 90 51 FF	
Get Focus Position	81 09 04 48 FF	90 50 0Z 0Z 0Z 0Z FF	ZZZZ = Position LSB = 0.5 deg.

9.4 Pan/Tilt Mechanism

This section describes the structure of the commands for the Pan/Tilt on the PTZ-35 MS / PTZ-50 MS Sensor. Note that all data values are called out in hexadecimal. The command and response strings of the Pan / Tilt Mechanism interface are of variable length, ranging from 5 to 32 bytes. The format for these command / response strings differs from the IR Imager in that the number of data bytes is not included in the string. Rather the word is terminated by an “End-Of-Word” byte. The byte descriptions are as follows:

Byte 1 Process Code (8 plus the Pelco Address) ie. 81 is Pelco 01
 Byte 2 Read / Write
 Byte 3 Device
 Byte 4 Function Code
 Byte Data Byte i (first byte)
 ... {Variable, 0 to 27 data bytes total}
 Byte Data Byte j (last Byte)
 Byte_n End Of Word

where: n = 5 + Number of Data Bytes

Pan/Tilt Commands/Responses

Command	Command Word	System Response	Notes
Up	81010601VVWW030 FF	90 41 FF 90 51 FF	VV=Pan Speed, 0 to FE _H , FE _H = fastest WW=Tilt Speed, 0 to FE _H , FE _H = fastest Min value = 28 _H typical
Down	81010601VVWW0302FF	90 41 FF 90 51 FF	VV=Pan Speed, 0 to FE _H , FE _H = fastest WW=Tilt Speed, 0 to FE _H , FE _H = fastest Min value = 28 _H typical
Left	81010601VVWW0103 FF	90 41 FF 90 51 FF	VV=Pan Speed, 0 to FE _H , FE _H = fastest WW=Tilt Speed, 0 to FE _H , FE _H = fastest Min value = 28 _H typical
Right	81010601VVWW0203 FF	90 41 FF 90 51 FF	VV=Pan Speed, 0 to FE _H , FE _H = fastest WW=Tilt Speed, 0 to FE _H , FE _H = fastest Min value = 28 _H typical
Up Left	81010601VVWW0101 FF	90 41 FF 90 51 FF	VV=Pan Speed, 0 to FE _H , FE _H = fastest WW=Tilt Speed, 0 to FE _H , FE _H = fastest Min value = 28 _H typical
Up Right	81010601VVWW0201 FF	90 41 FF 90 51 FF	VV=Pan Speed, 0 to FE _H , FE _H = fastest WW=Tilt Speed, 0 to FE _H , FE _H = fastest Min value = 28 _H typical
Down Left	81010601VVWW0102 FF	90 41 FF 90 51 FF	VV=Pan Speed, 0 to FE _H , FE _H = fastest WW=Tilt Speed, 0 to FE _H , FE _H = fastest Min value = 28 _H typical
Down Right	81010601VVWW0202 FF	90 41 FF 90 51 FF	VV=Pan Speed, 0 to FE _H , FE _H = fastest WW=Tilt Speed, 0 to FE _H , FE _H = fastest Min value = 28 _H typical
Stop	81010601VVWW0303 FF	90 41 FF 90 51 FF	

Home			
Goto	80 01 06 04 03 FF	90 41 FF 90 51 FF	Go to Home Position
Set	81 01 06 04 02 FF	90 41 FF 90 51 FF	Set Home position to current P/T position
Get Pan/Tilt Position	81 09 06 12 FF	90 50 0P0Q 0R 0S 0T 0U 0V 0W 0V 0W FF	PQR.S=Pan, TUV.W=Tilt, HEX, LSB=1/2deg
Presets			
Go To (Absolute Position)	81 01 06 02 GG HH 0a 0b 0c 0d 0e 0f 0g 0h FF	90 41 FF 90 51 FF	PQRS=Pan Posit., PQR.S _H ° TUVW=Tilt Posit., TUV.W _H ° example 135.5 = 00 08 07 08, LSB=1/2° GG=Pan Speed, 00H to 18H, 18H= 86 deg/s, 00H=5 deg/s
Set (Current Position)		90 41 FF 90 51 FF	HH= Tilt Speed

10.0 USER CONTROLS FOR KBD300A

To start type Pelco Address then CAM

Keystrokes	PTZ-35 MS / PTZ-50 MS Function	Toggle Values (default to first value)
Near button	Increments DLTV Focus closer	
Far button	Increments DLTV Focus farther	
CW Joystick	Increments DLTV Zoom closer	
CCW Joystick	Increments DLTV Zoom farther	
1, Aux On	IR Polarity to Black Hot	
1, Aux Off	IR Polarity to White Hot	
2, Aux On	Set IR to 2X ezoom	
2, Aux Off	Set IR to 1X ezoom	
3, Aux On	Toggle: Plateau Values	250, 300, 400, 50, 150, 200
3, Aux Off	Toggle: AGC Type	Plateau, AutoBright, Linear, Plateau, AutoBright, Linear
4, Aux Off	IR FFC	
5, Aux Off	Toggle: LUT Palette	White, Black, Sepia, Color1, Firelce, Rain
6, Aux On	Toggle: DDE gain in photon	32, 64, 96, 128, 16, 24
6, Aux Off	Toggle: AGC ROI	Full, Horizon, Sky, Ground, Center, Center(smaller)
7, Aux On	Toggle: MID ITT in Photon	140, 160, 200, 60, 100, 120
7, Aux Off	Toggle: Max gain value	8, 10, 12, 2, 4, 6

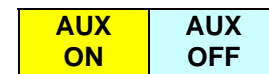

1	2	3
4	5	6
7	8	9
CAM	0	CLEAR

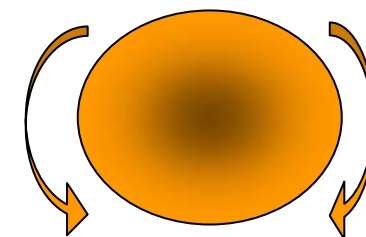

Note: If communication unsuccessful either type 0,1 CAM or disconnect and then reconnect the keyboard